

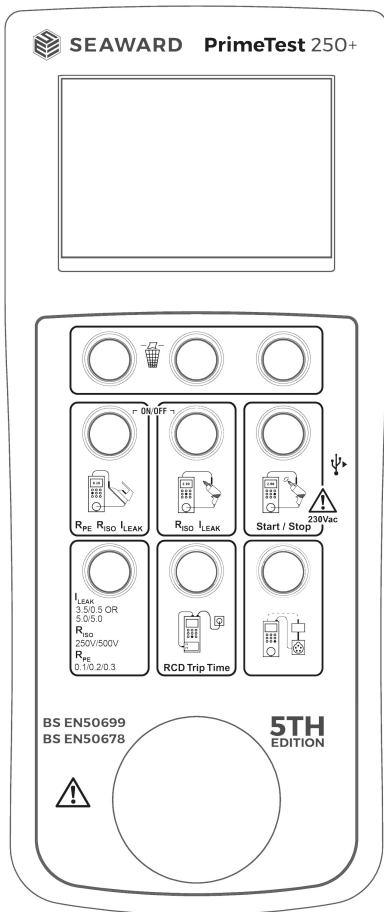

SEAWARD

PrimeTest 250+



Operating Instructions

PrimeTest 250+

Operating Instructions

Bracken Hill
South West Industrial Estate
Peterlee
Co Durham
SR8 2SW
ENGLAND
Tel: +44(0)191 586 3511
www.seaward.com
sales@seaward.com
service@seaward.com

Part Number 403A556 Revision 6
© 2022 Seaward Electronic Ltd

Limited Warranty & Limitation of Liability

SEAWARD Electronic Limited guarantees this product to be free from defects in material and workmanship under normal use and service for a period of 1 year. The period of warranty will be effective from the day of delivery.

24 Month Warranty Statement

Seaward provides a standard 12-month manufacturer's warranty against breakdown during normal use. This warranty can be upgraded to a 24-month warranty by registering your product with Seaward within 30 days of purchase and having it calibrated at an authorised service centre within 13 months of purchase.

For full terms and conditions or to register your product, please visit our website:

www.seaward.com/warranty24

(c) Copyright 2022

All rights reserved. Nothing from this edition may be multiplied, or made public in any form or manner, either electronically, mechanically, by photocopying, recording, or in any manner, without prior written consent from SEAWARD Electronic Limited. This also applies to accompanying drawings and diagrams.

Due to a policy of continuous development SEAWARD Electronic Limited reserves the right to alter the equipment specification and description outlined in this publication without prior notice and no part of this publication shall be deemed to be part of any contract for the equipment unless specifically referred to as an inclusion within such contract.

Disposal of old product

This product has been designed and manufactured with high quality materials and components that can be recycled and reused.

When this symbol is attached to a product it means the product is covered by the European Directive.

Please familiarise yourself with the appropriate local separate collection system for electrical and electronic products.

Please dispose of this product according to local regulations. Do not dispose of this product along with normal waste material. The correct disposal of this product will help prevent potential negative consequences for the environment and human health.

Contents

1	Important Information	5
2	Introduction.....	16
3	Performing Tests	18
3.1	Checking a mains power outlet	18
3.2	Testing a Class I Appliance	19
3.4	Testing a mains cord	27
3.5	Testing an extension lead.....	28
3.6	Changing the Insulation Test Voltage ...	29
3.7	Changing the Leakage Limits	29
3.8	Performing an RCD test on an installation RCD	30
3.9	Performing an RCD test on a Plug top RCD	31
3.10	Performing a 3-Phase Sequence	32
4	Memory & Print Functions.....	34
4.1	Saving Test Results.....	34
4.2	Viewing Test Results	34
4.3	Deleting Test Results	34
4.4	Transferring Test Results	35
4.5	Printing Test Results	35
4.6	Setting the Real Time Clock	36
5	Specification	37
6	Maintenance	39
7	Battery Check.....	39
7.1	Battery Replacement	40
8	Fuse Replacement.....	41
9	Service and Calibration	42

1 Important Information

These operating instructions are intended for the use of adequately trained personnel.

The following symbols are used in these operating instructions and on the PrimeTest 250+.



Caution, risk of electric shock.

Indicates instructions must be followed to avoid danger to persons.



Caution, risk of danger. The operating

instructions must be adhered to in order to avoid danger.

Before use, ensure unit is clean and dry; visually inspect all leads, connectors, and case. Any damage or wear must be rectified prior to use.



If the PrimeTest 250+ is used in a manner not specified by these operating instructions then the protection provided may be impaired.



Always ensure that the circuit or appliance under test is electrically isolated.



The PrimeTest 250+ and all associated cables and leads must be checked for signs of damage before equipment is operated. Do not use if there are signs of damage. Only use the correct leads supplied with the PrimeTest 250+.



Do not touch test probes beyond the hand barrier on the test probe.



The PrimeTest 250+ may apply high voltage or mains power to the appliance under test. Do not touch conductive parts of the appliance while tests are active.



If the PrimeTest 250+ is being used to determine the presence or absence of hazardous voltages, always prove the operation of voltage measurement function before and after use by means of a known voltage source or proving unit.



Do not operate the PrimeTest 250+ in an explosive gas or dust environment.



The PrimeTest 250+ has been designed to make measurements in a dry environment.



Do not open the PrimeTest 250+, no user serviceable parts.

Note: *Data may be lost or altered in virtually any electronic memory under certain circumstances. Therefore Seaward Electronic assumes no responsibility for financial losses or claims due to data lost or otherwise rendered unusable whether as a result of abuse, improper use, defects, disregard of operating instructions or procedures, or any allied causes.*

	Part Number
PrimeTest 250+ unit	403A910

Standard Accessories	Part Number
Carry Case	71G082
Black Test Lead 1m	305A950
IEC mains cord 0.5m	300A002
USB download lead	396A972
Support CD	403A759
Operating Instructions	403A556

Optional Accessories	Part Number
Test n Tag Pro Printer (serial)	339A933
Test n Tag label roll	339A9492
Pass Labels (1000 labels)	91B038
Fail Labels (1000 labels)	91B311
PAT Log Book	998A223
PATGuard 3	400A910
230-110V adapter	270A076
3 Phase Adaptor 5/16	209A911
3 Phase Adaptor 5/32	209A913
3 Phase Adaptor 4/16	209A910
3 Phase Adaptor 4/32	209A912
3 Phase Leakage Adapter 5/16	391A920
3 Phase Leakage Adapter 5/32	391A910
NiMH Batteries and charger	339A950

PATGuard 3 can be trialled and purchased online from the below web address:

www.seaward.com/pg3

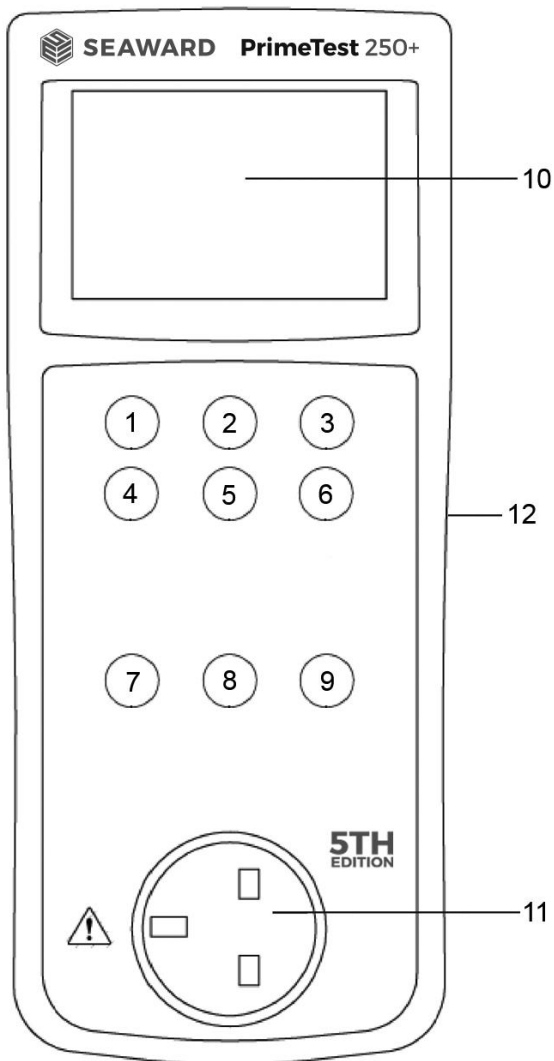

Figure 1. PrimeTest 250+ Front View

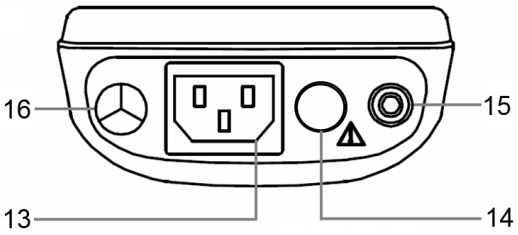

Figure 2. PrimeTest 250+ End View

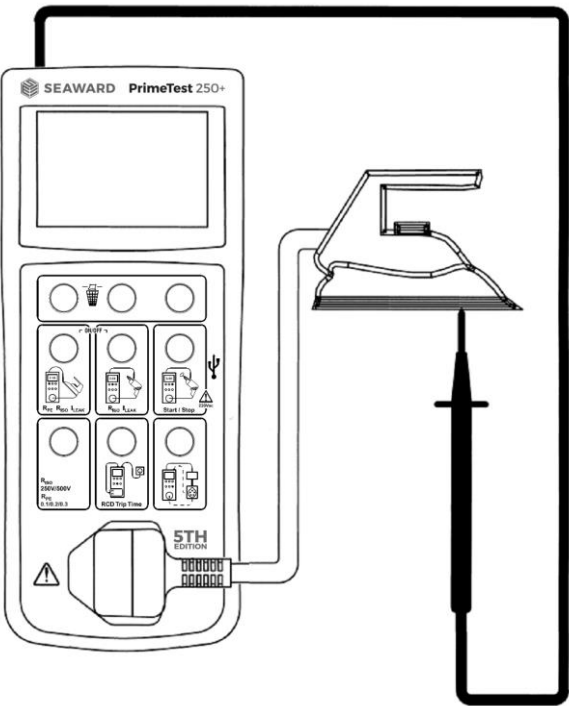

Figure 3. Testing CLI appliances, no mains leakage

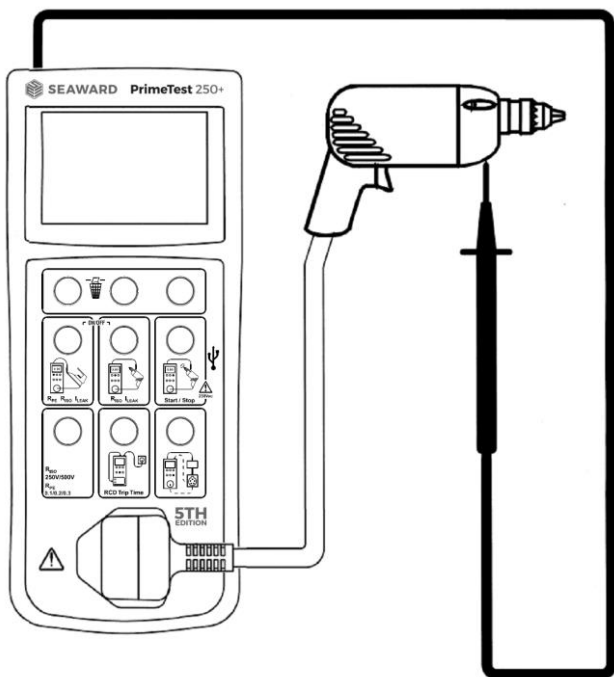

Figure 4. Testing CLII appliances, no mains leakage

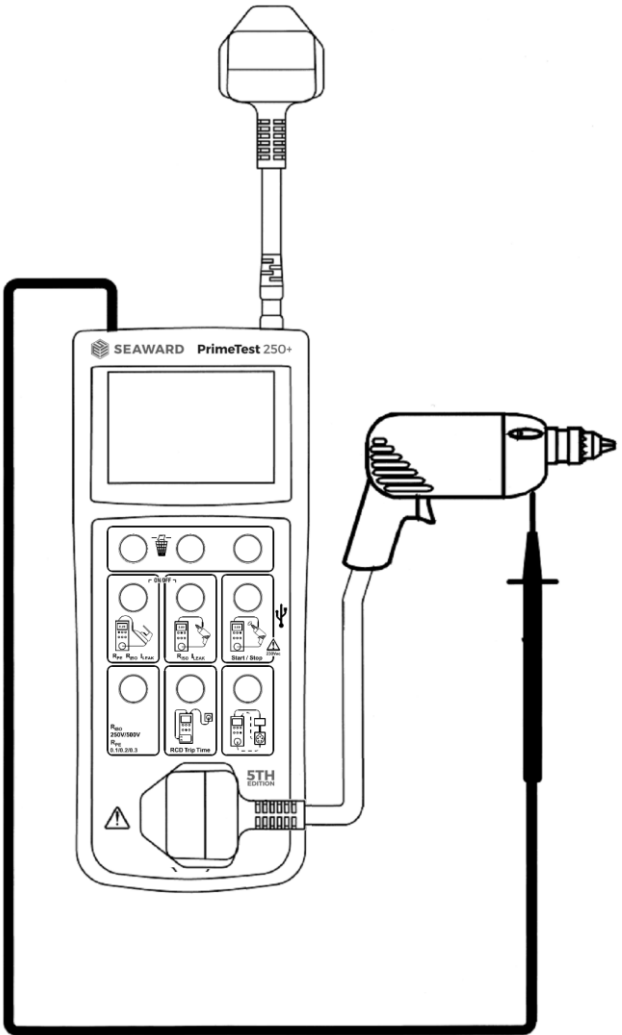

Figure 5. Testing CLI appliances, mains leakage

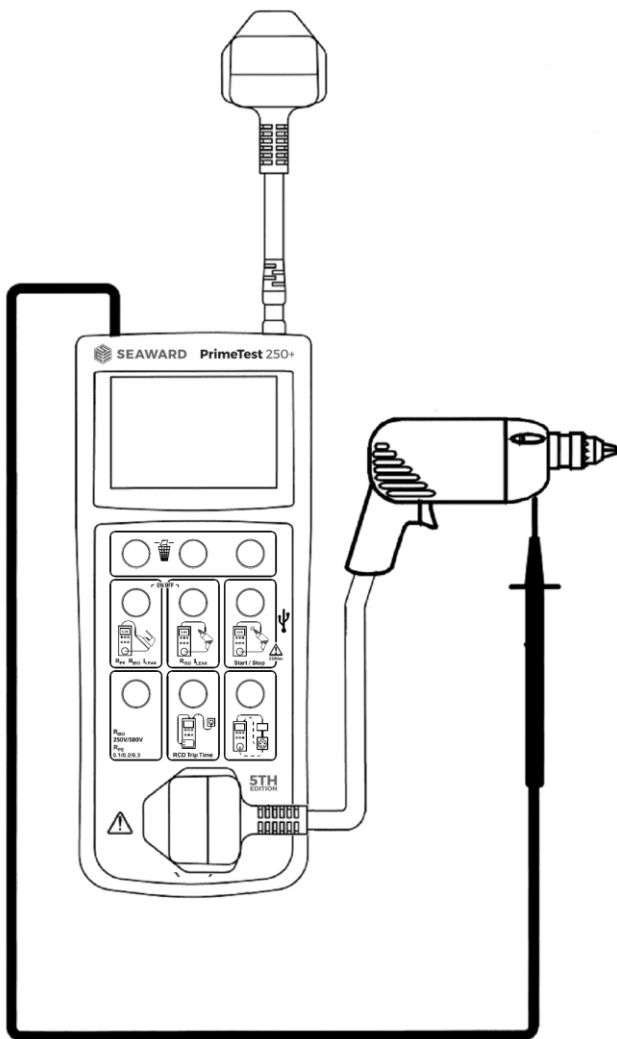

Figure 6. Testing CLII appliances, mains leakage

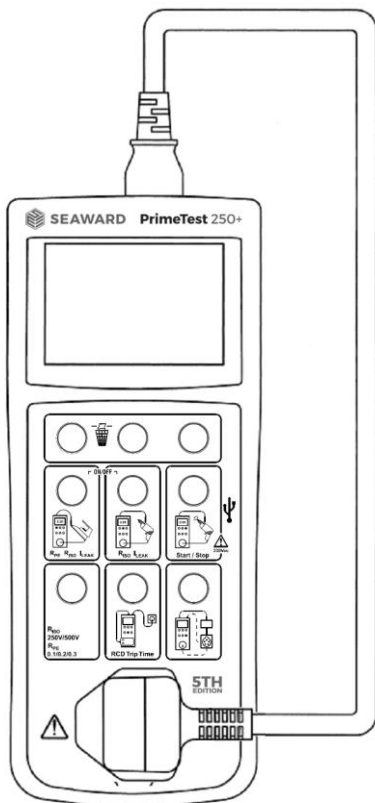

Figure 7. Testing IEC Leads

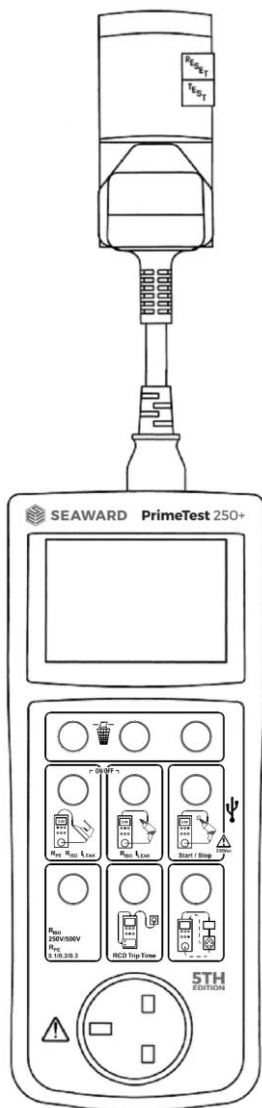

Figure 8. Testing Installation RCD

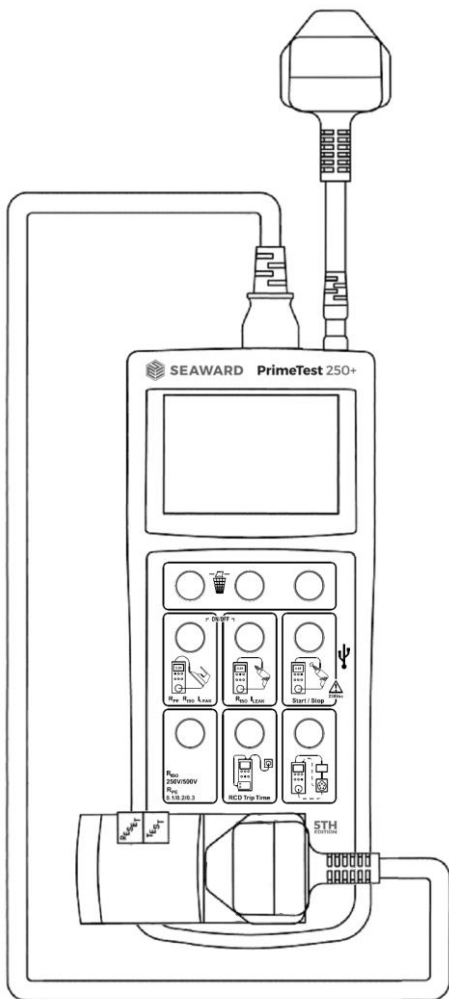

Figure 9. Testing Plug Top RCD

2 Introduction

The PrimeTest 250+ is a hand held battery powered unit suitable for carrying out electrical safety checks on:

- Class I appliances
- Class II appliances
- Class II FE
- IEC mains leads
- Extension leads
- 30mA Plug-top RCDs
- 30mA Installation RCDs
- Mains outlet wiring
- 3-Phase appliances when used with the Seaward TPA range of 3-phase adaptors.

Overview

With reference to Figures 1 and 2.

1. Save Key
2. Recall Key
3. Print Key
4. CLI / Cord Sequence Key
5. CLII Test Sequence Key
6. Leakage Test Start Key
7. Setup Button
8. RCD Test Key
9. 3-Phase Test Sequence Key
10. LCD
11. Test/Mains outlet socket
12. USB Interface
13. IEC Test Connection
14. Mini DIN Printer Interface
15. Earth Continuity Test Terminal
16. Mains inlet socket

User Interface

The LCD display shows test progress, results for individual tests and the overall test result for an appliance or mains cord.

Power ON/OFF = press and hold the CLI ④ and CLII ⑤ keys simultaneously

Class I appliance test = press the CLI key ④

Class II appliance test = press the CLII key ⑤

Cord / extension lead test = press the CLI key ④

Enter Setup Mode = press the setup key ⑦

Once in the setup mode the CLII button can be used to change the Insulation resistance test voltage, the Class I button can be used to change the earth continuity, and the LKGE button can be used to change leakage limits. To leave the setup mode press the setup button.

30mA RCD test = press the 30mA RCD key

3 phase appliance test = press the 3 phase key

Note: The PrimeTest 250+ will automatically switch OFF after approximately 1 minute if no keys are pressed.

Note: When a key is pressed to initiate a test sequence, the PrimeTest 250+ will compare the type of appliance connected with the test sequence that has been selected, and where possible, will prompt the user if an inappropriate test has been selected.

For example, if an IEC lead is connected between the front panel mains socket and the IEC socket on the end panel and a CLI appliance test is selected, the PrimeTest 250+ will flash the Cord test enunciator to indicate that the Cord test is the most appropriate test.

3 Performing Tests

Press the CLI ④ and CLII ⑤ keys simultaneously to switch on the PrimeTest 250+. When the unit is ready the display will be as shown below.



3.1 Checking a mains power outlet

Connect PrimeTest 250+ mains lead to the mains inlet socket and to the power outlet to be tested.

Each time mains voltage is detected, the line-neutral, line-earth and neutral-earth voltages will be displayed for 2s as shown below.

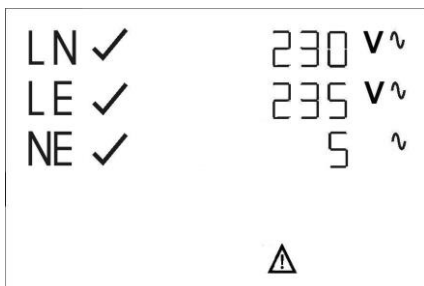

If the voltages are within the acceptable limits shown below, a tick is shown next to the enunciator.

LN	195V-253V
LE	195V-253V
NE	<30V

After 2s the display will return to the start up screen.

If the mains voltage is incorrect then the PrimeTest 250+ will remain in voltage mode until the voltage is corrected or removed.

3.2 Testing a Class I Appliance

- Visually inspect the appliance and mains cord for signs of damage.
- If the appliance passes a visual inspection proceed with the electrical tests.
- Plug the earth test lead into the Earth Continuity Test Terminal on the PrimeTest 250+ end panel.
- Plug the appliance into the PrimeTest 250+ front panel test/mains outlet socket.
- Connect the earth test probe to an exposed metal part on the appliance.
- If the appliance under test has an ON/OFF switch, make sure it is in the ON position.
- Press the CLI test key ④
- The PrimeTest 250+ will now perform a measurement of the protective earth continuity, reverse the test current and repeat the measurement. The highest measured value that occurred during the two tests is displayed.
- If you are testing a Class I item with no exposed earthed parts an option to accept the high continuity measurement is given. When the continuity test fails you can long press key ④ and the continuity and show as NC (not checked) on the result screen.
- If the continuity measurement is greater than the set limit but $<0.5\text{ohms}$ then the PrimeTest 100 will ask whether a long lead is attached. Press the key ④ to record the result as a pass or the key ⑤ to record a fail.

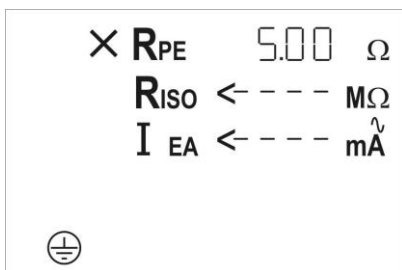

- If the measured value is less than the pre-set pass/fail threshold, the measured value is displayed and the unit indicates a pass result, as shown below.

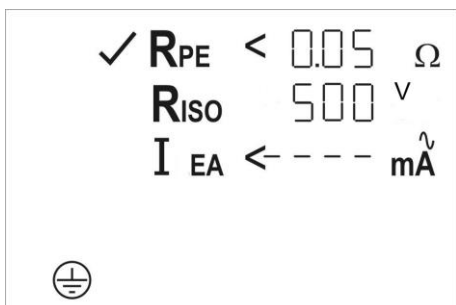

Note: The PrimeTest 250+ can perform a continuous Rpe measurement (max 3 minutes). Press and hold the CLI key ④ for approximately 5s until the unit emits a beep and the symbol appears on the display. The PrimeTest 250+ continuously displays the current measured value on the display and stores the maximum value in the memory. By pressing the CLI key ④ again, the measurement is repeated with reversed polarity. Press the key again to terminate the Rpe test and display the maximum value of RPE on the display.

- The insulation test voltage is shown momentarily next to the Riso enunciator.
- The unit will proceed with the Insulation and Leakage tests.

Note: *The power switch on the appliance under test must be in the ON position to perform an insulation test. If no appliance is detected the PrimeTest 250+ will display the following.*

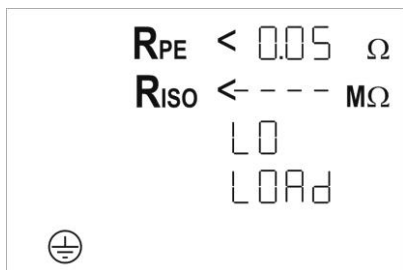

- Check that the appliance power switch is in the ON position. The test will automatically proceed if the appliance power switch is placed in the ON position.
- If the **LO LOAd** enunciator remains on the display, the load presented by the appliance may be too small for the PrimeTest 250+ to detect. In this case, press the CLI test key ④ to continue.
- If the Insulation Resistance is greater than the factory set limit a tick is placed next to the **Riso** enunciator. If the Insulation Resistance is less than the set limit a cross is placed next to the **Riso** enunciator, the **FAIL** enunciator is displayed and the test sequence is halted.

Note: *If a mains supply is detected, the PrimeTest 250+ will perform a differential leakage test.*

If the PrimeTest 250+ does not detect a mains supply then the PrimeTest 250+ will perform a substitute leakage test.

- If a substitute leakage test is performed then the PrimeTest 250+ will start the test without the need for user intervention. If the substitute leakage is less than the factory set limit a tick is placed next to the **lea** enunciator.

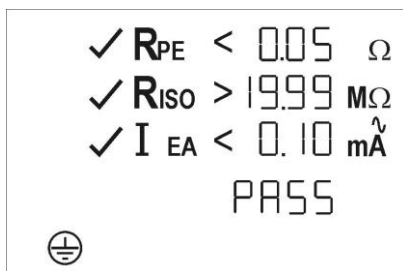

- If a differential leakage test is performed then the test PrimeTest 250+ will prompt the user to start the Leakage test by flashing the **lleak** icon. If no key is pressed the PrimeTest 250+ will timeout and return to the start screen.

Note: *If the LKGE key  is pressed momentarily the differential test duration is 5s.*

If the LKGE key  is pressed and held for 2s the differential test duration is 2 minutes.

When the duration is set to 2 minutes, the test can be terminated at any time by pressing the LKGE key .

- When the LKGE key  is pressed to start the differential leakage test the PrimeTest 250+ will check the incoming mains supply to ensure that the voltages are correct. The enunciators are displayed if there is an error with the connected mains supply:

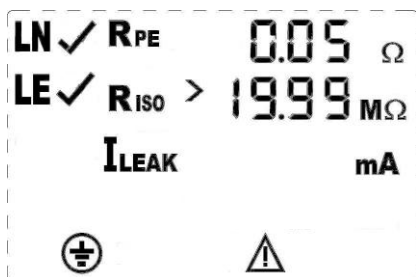

LN	LE	NE	Mains status
Flash	Flash	OFF	No mains
OFF	Flash	Flash	Earth fault or Live and Neutral reverse

- If the mains voltage is correct, the PrimeTest 250+ will proceed with the differential leakage test.



- If the Differential Leakage is less than the factory set limit a tick is placed next to the **leak** enunciator.
- If all of the tests within the sequence have passed then the **PASS** enunciator is illuminated.

3.3 Testing a Class II Appliance

- Visually inspect the appliance and mains cord for signs of damage.
- If the appliance passes a visual inspection proceed with the electrical tests.
- Plug the earth test lead into the Earth Continuity Test Terminal on the PrimeTest 250+ end panel.
- Plug the appliance into the PrimeTest 250+ front panel test/mains outlet socket.
- Connect the earth test probe to an exposed metal part on the appliance.
- If the Appliance under test has an ON/OFF switch, make sure it is in the ON position.
- Press the CLII test key 
- Should an earth path be picked up at the start of the test a message will appear asking to confirm that the EUT is Class II FE if it is and you wish to continue the test then press class II key  and the test will start. The value for the continuity will be shown but no pass/fail marker against it. It will then carry on with the following tests but automatically drop the test voltage to 250V for the insulation resistance.
- The display will momentarily show the insulation test voltage before proceeding with the test.

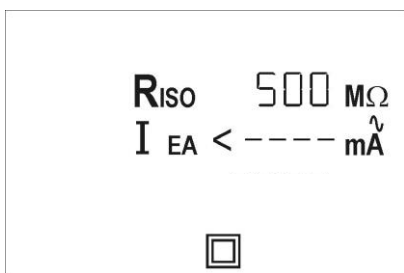

Note: The power switch on the appliance under test must be in the ON position to perform an insulation test. If no appliance is detected the PrimeTest 250+ will display the following.

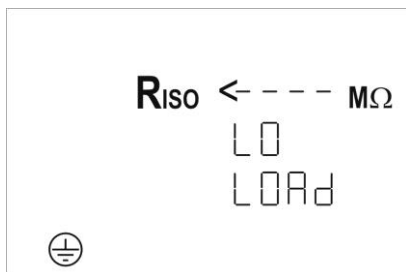

- Check that the appliance power switch is in the ON position. The test will automatically proceed if the appliance power switch is placed in the ON position.
- If the **LO LOAD** enunciator remains on the display, the load presented by the appliance may be too small for the PrimeTest 250+ to detect. In this case, press the CLII test key  to continue.
- The PrimeTest 250+ will perform an Insulation test. If the Insulation Resistance is greater than the factory set limit a tick is placed next to the **Riso** enunciator. If the Insulation Resistance is less than the set limit a cross is placed next to the **Riso** enunciator, the **FAIL** enunciator is displayed and the test sequence is halted.



Note: *If a mains supply is detected, the PrimeTest 250+ will perform a touch leakage test.*

If the PrimeTest 250+ does not detect a mains supply then the PrimeTest 250+ will perform a substitute leakage test.

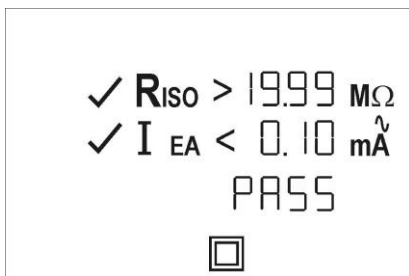
- If a Substitute Leakage test is performed then the PrimeTest 250+ will start the test without the need for user intervention. If the Substitute Leakage is less than the factory set limit a tick is placed next to the **I_{EA}** enunciator.



- If a touch leakage test is performed then the PrimeTest 250+ will prompt the user to start the Leakage test by flashing the **leak** icon. If no key is pressed the PrimeTest 250+ will timeout and return to the start screen.

Note: *If the LKGE key  is pressed momentarily the touch leakage test duration is 5s
If the LKGE key  is pressed and held for 2s the touch leakage test duration is 2 minutes.*

When the duration is set to 2 minutes, the test can be terminated at any time by pressing the LKGE key .

- When the LKGE key  is pressed to start the touch leakage test the PrimeTest 250+ will check the incoming mains supply to ensure that the voltages are correct. The enunciators are displayed if there is an error with the connected mains supply:

LN	LE	NE	Mains status
Flash	Flash	OFF	No mains
OFF	Flash	Flash	Earth fault or Live and Neutral reverse

- If the mains voltage is correct, the **PrimeTest 250+** will proceed with the touch leakage test.

- If the touch leakage is less than the factory set limit a tick is placed next to the ***leak*** enunciator.
- If all of the tests within the sequence have passed then the ***PASS*** enunciator is illuminated.

3.4 Testing a mains cord

- Visually inspect the mains cord and plug for signs of damage.
- Check that the correct fuse is fitted.
- If the cord passes a visual inspection proceed with the electrical tests.
- Plug the mains cord under test into the IEC socket and the front panel test/mains socket on the PrimeTest 250+.
- Press the CLI test key ④
- The PrimeTest 250+ will first test the continuity of the protective earth.
- If the measured value is greater than the pre-set limit a cross is placed next to the ***R_{PE}*** enunciator, a FAIL is indicated and the test sequence will be halted.
- If the continuity measurement is greater than the set limit but $<0.5\text{ohms}$ then the Primetest 250+ will ask whether a long lead is attached. Press the key ④ to record the result as a pass or the key ⑤ to record a fail.
- If the measured value is less than the pre-set limit a tick is placed next the ***R_{PE}*** enunciator.
- The unit will proceed with the Insulation test.
- If the Insulation Resistance is lower than the factory set limit a cross is placed next to the ***Riso*** enunciator and the test sequence is halted.
- If the Insulation Resistance is greater than the factory set limit a tick is placed next to the ***Riso*** enunciator. If the Insulation Resistance is less than the set limit a cross is placed next to the ***Riso*** enunciator, the ***FAIL*** enunciator is displayed and the test sequence is halted.

- The unit will proceed with the wiring test, checking the live and neutral conductors for short or open circuit and reverse connections
- If the wiring is correct a tick is placed next to the cord enunciator, the **GOOD** enunciator is illuminated and a **PASS** is indicated for the sequence.

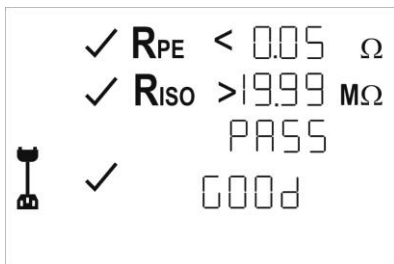

Note: If the tested cord has a wiring fault, one of the following enunciators will be illuminated in place of GOOD

- **OPEN** indicates that either the line or neutral conductor is broken (open circuit)
- **Shor** indicates that the line and neutral conductors are shorted together
- **CrOS** indicates that the line and neutral conductors are reversed

3.5 Testing an extension lead

- Visually inspect the mains cord and plug for signs of damage.
- Check that the correct fuse is fitted.
- If the cord passes a visual inspection proceed with the electrical tests.
- Plug the supplied 0.5m IEC lead into the IEC socket and into a mains outlet on the extension lead. Plug the mains plug of the extension lead into the front panel mains socket on the PrimeTest 250+.

- The extension lead can now be tested in the same manner as an IEC as described above.
- If the continuity measurement is greater than the set limit but $<0.5\text{ohms}$ then the PrimeTest 250+ will ask whether a long lead is attached. Press the key ④ to record the result as a pass or the key ⑤ to record a fail.

3.6 Changing the Insulation Test Voltage

The Insulation test performed in the CLI and CLII test sequences can be changed to 250V for appliances with MOVs which would fail an Insulation test performed at 500V.

In order to change the Insulation voltage press the setup button ⑦ to enter setup mode. Once in setup mode press the CLII button ⑤, the selected insulation voltage will be displayed next to the **Riso** enunciator.

To leave setup mode press the setup button ⑦.

3.7 Changing the Leakage Limits

The leakage limits can be changed to suit the users chosen guidance standard, either performed at IET Code of Practice levels (5mA CI1 and 5mA CI2) or BS EN 50699 levels (3.5mA CI1 and 0.5mA CI2).

In order to change the leakage limit between the press the setup button (7) to enter setup mode. Once in setup mode press the LKGE button, the selected standard will be displayed along with the relevant pass levels.

To leave setup mode press the setup button .

3.8 Performing an RCD test on an installation RCD



When performing an RCD test ensure that the Continuity Test probe is disconnected from the PrimeTest 250+



Equipment which is connected downstream of the RCD may cause measurement inaccuracies.



Voltages between the protective conductor and earth may influence measurements.



Leakage currents in the circuit may influence measurements.



Potential fields of other earthing installations may influence the measurement.

The PrimeTest 250+ can be used to measure the operating time of an installation RCD.

Connect the PrimeTest 250+ IEC lead to the IEC socket of the PrimeTest 250+ and a mains outlet on the RCD protected circuit.

To test the RCD operating time press the 30mA RCD test key .

The mains supply status is checked and the status is indicated using the LN, LE and NE enunciators of the LCD.

LN	LE	NE	Mains status
Flash	Flash	OFF	No mains
OFF	Flash	Flash	Earth fault

Whenever reSet is displayed on the LCD press the reset button on the RCD.

The PrimeTest 250+ will perform a $I_{\Delta n}$ (30mA) 0° test, the operating time of the RCD will be shown on the PrimeTest 250+ LCD. If the test passes then the PrimeTest 250+ will perform a $I_{\Delta n}$ (30mA) 180° test. As long as the tests continue to pass the PrimeTest 250+ will continue to test both 0° and 180° at $I_{\Delta n}$ (30mA).

3.9 Performing an RCD test on a Plug top RCD

The PrimeTest 250+ can be used to measure the operating time of a plug top RCD.



When plugging the mains lead into the PrimeTest 250+ plus ensure that the polarity orientation of the connector is correct. DO NOT FORCE THE PLUG INTO THE CONNECTOR. Doing so may damage the PrimeTest 250+.



When performing an RCD test ensure that the Continuity Test probe is disconnected from the PrimeTest 250+.

Connect the PrimeTest 250+ mains lead to the mains inlet socket of the PrimeTest 250+ and a mains outlet.

Plug the RCD into the PrimeTest 250+. Plug the supplied IEC lead into the RCD and the PrimeTest 250+ IEC socket.

To test the RCD operating time press the 30mA RCD test key . ⑧

The mains supply status is checked and the status is indicated using the LN, LE and NE enunciators of the LCD.

LN	LE	NE	Mains status
Flash	Flash	OFF	No mains
OFF	Flash	Flash	Earth fault

Whenever reSet is displayed on the LCD press the reset button on the RCD.

The PrimeTest 250+ will perform a $I_{\Delta n}$ (30mA) 0° test, the operating time of the RCD will be shown on the PrimeTest 250+ LCD. If the test passes then the PrimeTest 250+ will perform a $I_{\Delta n}$ (30mA) 180° test. As long as the tests continue to pass the PrimeTest 250+ will continue to test both 0° and 180° at $I_{\Delta n}$ (30mA).

3.10 Performing a 3-Phase Sequence

The PrimeTest 250+ can be used to measure Rpe and earth leakage current on 3 phase equipment when used with the optional 3 phase adaptor accessory.

- Visually inspect the appliance and mains cord for signs of damage.
- If the appliance passes a visual inspection proceed with the electrical tests.
- Refer to the documentation supplied with the 3 phase adaptor and connect the adaptor in line with the 3 phase equipment under test.
- Connect the 3 phase adaptor test lead to the mains input socket 9 (refer to figure 2) on the PrimeTest 250+.
- Connect the Rpe test probe to an exposed conductive part on the 3 phase equipment.
- Press the 3 phase key $\textcircled{9}$ on the PrimeTest 250+ to begin the test.
- If there is a contact voltage present on the conductive parts of the equipment under test, the test is terminated and a **Volt on test Probe** warning message is shown on the display.

- Otherwise, the PrimeTest 250+ will proceed with the Rpe measurement, reverse the test current and then repeat the measurement. The highest measured value that occurred during the two tests is displayed for approximately 2s.

Note: There is no factory programmed test limit for the 3 phase Rpe measurement and so no tick or cross is displayed.

- The PrimeTest 250+ will then display the current flowing in the protective conductor of the 3 phase supply.



- The 3 Phase leakage test will run for 30 seconds but can be stopped earlier by pressing the 3 Phase button (9).

Note: If the 3-Phase key (9) is pressed while no adaptor is connected to the PrimeTest 250+ then a warning message PLUG IN 3 PH ADPTR will be displayed.

4 Memory & Print Functions

The PrimeTest 250+ can store the results for a maximum of 999 appliances.

4.1 Saving Test Results

In order to store a test result press the store ① key when the test sequence has been completed. The results displayed on the LCD will be recorded in memory. Once the results for a test sequence have been recorded the store ① key is disabled until another test sequence has been performed.

4.2 Viewing Test Results

When the PrimeTest 250+ is waiting to start a new test sequence press the recall ② Key, this will display the last recorded results. Other results can be displayed by scrolling through the memory. To scroll through the memory use the recall ② and store ① keys. Pressing any other key or waiting for 10 seconds will return the PrimeTest 250+ into test mode.

4.3 Deleting Test Results

To delete all of the results in memory press and hold the store ① and recall ② keys together while displaying the recalled results until the counter reaches zero.

4.4 Transferring Test Results

Test data can be transferred to a PC using the Datalogger on the provided

seaward.com/ptdatalogger Download the file and then view the InstallationInstructions.txt file for information on how to install.

Once the USB drivers and Datalogger are installed you can open the Datalogger program from your desktop.

Connect your device to the PC using a USB connector. (The very first time you do this, your PC will automatically install a COM port driver). You can check which COM port is being used by looking in the Device manager.

E.g.: Silicon Labs CP210x USB to UART Bridge(COM14)

Select the correct COM port.

Click on Download. A progress bar will appear.

On the PrimeTest 250+ in order to transfer the entire test storage area to PC press and hold the recall key ② for 5 seconds. The data will be transmitted using the USB interface.

When all data has been captured and stored the progress bar will disappear and you will be asked where to save the data.

Once the file is saved you may click the "Open" button to open the document with default application. For example, if you saved the file in .csv format (the default) then it may open using a spreadsheet application.

4.5 Printing Test Results

In order to print a test label press the print key ③ when the test sequence has been completed or when the test result is being reviewed. The printer must be attached before the print key ③ is pressed. In order to save power the PrimeTest 250+ will turn the printer on and off when required.

4.6 Setting the Real Time Clock

Setting time and date:

Ensure that the PrimeTest 250+ is powered off.

Press and hold the recall key ② and then press simultaneously the class I and class II keys to power on the tester.

The date format and time format is shown as follows:

MM.DD = month (1-12). Day (1-31)

YYYY = year

HH.mm = hours (0-23).minutes (0-59)

SS = seconds (0-59)

Press the class I key to select a date field and time field.

A flashing digit shows that this field can be set.

The save key ① and recall key ② are used to increase or decrease the value in each field, the second field is set to zero.

Turn off the device to save the setting.

5 Specification

Earth Continuity

Display Range	0.01ohms to 19.99ohms
Measuring Range	0.05ohms to 19.99ohms
Accuracy	± (5% + 2 digits)
Test current	200mA minimum
Test voltage	6V nominal

Insulation resistance

Display Range	0.01Mohms to 19.99Mohms
Measuring Range	0.10Mohms to 19.99Mohms
Accuracy	± (5% + 2 digits)
Test voltage	250V / 500V
Test current	>1mA
Test current	<2mA into 2k

Substitute Leakage Current

Display Range	0.10mA to 19.99mA
Measuring Range	0.25mA to 19mA
Accuracy	± (5% + 2 digits)
Test voltage	40V rms, 50Hz AC
Test current	<10mA into 2k

Differential Leakage Current

Display Range	0.15mA to 19.99mA
Measuring Range	0.25mA to 19mA
Accuracy	± (5% + 2 digits)
Test voltage	mains voltage, 50Hz AC

Touch Leakage Current

Display Range	0.10mA to 5.0mA
Measuring Range	0.10mA to 5.0mA
Accuracy	± (5% + 2 digits)
Test voltage	mains voltage, 50Hz AC

3-Phase Leakage Current

Display Range	0.10mA to 9.99mA
Measuring Range	0.25mA to 9.99mA
Accuracy	± (5% + 2 digits)
Test voltage	mains voltage, 50Hz AC

Cord Test

Earth continuity, insulation resistance as above.
Check for Line and Neutral open circuit, short circuit or reversed polarity.

RCD Test

Display Range	I Δ n - 0ms to 500ms 5I Δ n – 0ms to 40ms
Measuring Range	I Δ n - 10ms to 500ms 5I Δ n – 10ms to 40ms
Accuracy	\pm 2ms
Test Current	I Δ n – 30mA 5I Δ n – 150mA
Current Accuracy	-0, +10%

Pass/Fail Settings

	Class I	Class II	Class II FE	Cord/Lead
Earth Continuity	0.1/0.2/0.3 ohms	N/A	N/A*	0.1/0.2/0.3 ohms [^]
Insulation Resistance	1.0Mohm	2.0Mohm	2.0Mohm	2.0Mohm
Leakage	3.5 or 5mA	0.5 or 5mA	0.5 or 5mA	N/A

*Reads up to 20 ohms if Class 2 FE selected

[^]Reads up to 0.5 ohm if long lead selected

Environmental rating

IP Rating IP40

Operating temperature range 0°C to 40°C, without moisture condensation.

Storage temperature range –25° to 65°.

Note: Batteries should be removed prior to storage.

Overvoltage category 300V CAT II

6 Maintenance



Clean only with a dry cloth; do not use solvents. Before use, ensure unit is clean and dry; visually inspect all leads, connectors, and case. Any damage or wear must be rectified to preserve user safety.



Check the battery contacts and compartment are free of electrolytic contamination.

Any contamination of the battery contacts or compartment should be cleaned with a dry cloth.

Note: The PrimeTest 250+ contains no user serviceable parts. If an **Error** warning should appear on the display please contact the manufacturer or an **authorised Seaward Service Agent** for advise.

7 Battery Check

The PrimeTest 250+ is powered from 6 AA cells which are checked before a test is performed. When the battery voltage is low the   enunciator is illuminated. The unit will continue to perform within specification for a limited number of tests, dependent upon the type of the batteries fitted.

When the battery voltage reaches a level where the performance is affected the   enunciator will flash and all test keys are disabled. The batteries must be replaced.

7.1 Battery Replacement



Before opening the PrimeTest 250+ ensure that all test leads are disconnected.

- Switch off the unit by pressing and holding the CLI ④ and CLII ⑤ keys.
- Disconnect all leads from the PrimeTest 250.
- Place the PrimeTest 250+ face down and release the captive screw in the battery compartment cover.
- Remove the battery compartment cover and remove the discharged batteries.
- Insert the replacement batteries into the battery compartment ensuring that the battery polarity matches the marking on the inside of the battery compartment.
- Relocate the battery cover over the battery compartment and fasten in position with the battery cover captive screw.

8 Fuse Replacement



Before opening the PrimeTest 250+ ensure that all test leads are disconnected.

- Switch off the unit by pressing and holding the CLI ④ and CLII ⑤ keys.
- Disconnect all leads from the PrimeTest 250.
- Place the PrimeTest 250+ face down and release the captive screw in the battery compartment cover.
- Remove the battery compartment cover and remove the discharged batteries.
- Insert the replacement fuse into the fuse compartment ensuring that the fuse snaps into place.
- Relocate the battery cover over the battery compartment and fasten in position with the battery cover captive screw.

	Part Number
Replacement F16A 250V Fuse	27B114

9 Service and Calibration

To maintain the specified accuracy of the measurement results, the instrument must be recalibrated at regular intervals by either the manufacturer or an **authorised service agent**. We recommend a recalibration period of one year. For help or advice on Service and Calibration contact:

Service Department
Seaward Electronic Ltd
11 Bracken Hill
South West Industrial Estate
Peterlee
Co. Durham
SR8 2LS
United Kingdom

Email: service@seaward.com
Tel: +44 (0) 191 586 3511